

**LONYUNG**<sup>®</sup>  
LED INTEGRATED LIGHT MANUFACTURER

LONYUNG LED LIGHTING CO.,LTD



COMPANY WEBSITE



PRODUCT MANUAL

Copyright © LONYUNG 2010-2023

LONYUNG<sup>®</sup>

LED INTEGRATED LIGHT MANUFACTURER



**LONYUNG**<sup>®</sup>  
LED INTEGRATED LIGHT MANUFACTURER



# Natural Light

Lonyung Better Light



Lonyung  Search



# Content

LED INTEGRATED LIGHT MANUFACTURER

- L** About Lonyung 005-008
- O** Featured Products 009-022
- N** High Bay Fixture Series 023-036
- Y** Led Tri-proof Light Series 037-046
- U** Professional Light Series 047-056
- N** Led Integrated Light Series 057-064
- G** Reddot Award Product 065-070

- L** **About Lonyung**
- Lonyung Profile 005
- Certifications 006
- Company Culture 007-008

- O** **Featured Products**
- Linear Led Trunking Light 009-012
- Retrofit Led Linear Light 013-014
- 0-10V Dimming T8 Led Integrated Light 015-016
- 0-10V Dimming Double T5 Led Integrated Light 017-018

- N** **High Bay Fixture Series**
- Led Linear High Bay Light 019-020
- Led Double Linear High Bay Light ( I ) 021-022
- Led Double Linear High Bay Light ( II ) 023-024
- Led Linear High Bay Fixture 025-026

- Y** **Led Tri-proof Light Series**
- Led Tri-proof Light 027-028
- Mini Led Tri-proof Light 029-030
- Round Led Tri-proof Light 031-032
- Led Vapor Tight Fixture 033-034
- Plastic Led Integrated Light 035-036

- U** **Professional Light Series**
- Led Batten Light ( I ) 037-038
- Led Batten Light ( II ) 039-040
- Led Cabinet Light ( I ) 041-042
- Led Cabinet Light ( II ) 043-044

- N** **Led Integrated Light Series**
- Led T8 Integrated Light 045-046
- Single T5 Integrated Light ( I ) 047-048
- Single T5 Integrated Light ( II ) 049-050
- Double T5 Integrated Light ( I ) 051-052
- Double T5 Integrated Light ( II ) 053-054
- Led T8 Tube Light 055-056
- Led Phantom Light ( I ) 057-058
- Led Phantom Light ( II ) 059-060
- Formable Led Fixture 061-062
- Led UV Light Fixture 063-064

- G** **Reddot Award Product**
- Led Pod Light 065-066
- Led Camping Lantern 067-070



# Lonyung Profile

Since 2010

LONYUNG Led Lighting Co.,Ltd. is a high-tech enterprise specialized in the design, development, production and sales of LED lighting products. We were established in 2010 in Zhongshan City.

We are committed to promoting the application of LED lighting products and pay great attention to technological research and innovation. Until now, LONYUNG has obtained 69 patents and takes the lead in passing ISO9001 and BSCI. Our products are certificated under ETL, DLC, TUV-CE, RoHS, SAA, Ip65, Ik10, FCC, PSE.

Our main products include LED integrated tube, LED tri-proof light, LED linear high bay light, LED cabinet light etc. They are widely used in office buildings, houses and industrial areas. We have successfully established long-term partnership with clients from North America, Europe, Australia.

LONYUNG team sincerely welcomes your OEM/ODM requirement. Quality is our spirit. We will always provide you excellent products and services at competitive and reasonable cost. We sincerely invite you to visit us.

Let's make success together.

# Certifications

Energy Efficiency Certification



Until now, Lonyung has obtained more than 69 patents. At the same time, our products have approved safety certifications for North America, Europe, Australia and been rewarded with several Germany Red Dot Design Award.







# Company Culture

Light Up Your Life



## Because Of The Customer

Because the customer has a need,  
we have a job to do.

/

Because the customer has a choice,  
we must be the better choice.

/

Because the customer has sensibilities,  
we must be considerate.

/

Because the customer has an urgency,  
we must be quick.

/

Because the customer is unique,  
we must be flexible.

/

Because the customer has high expectations,  
we must excel.

/

Because the customer has influence,  
we have the hope of more customer.

/

Because of the customer,  
we exist!





# LED LINEAR UP/DOWN PENDANT LIGHT

This is an architectural and commercial style light fixture with an direct and indirect lighting. The light projects 70% of the light output downwards and 30% of the light upwards.

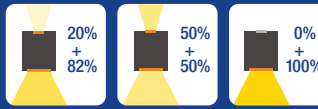

Direct & Indirect Options



Mobile APP  
Control available



# LED LINEAR UP/DOWN PENDANT LIGHT

This is an architectural and commercial style light fixture with an direct and indirect lighting. The light projects 70% of the light output downwards and 30% of the light upwards.



## Features

- ☑ Power percentage selectable.
- ☑ Three CCT switchable
- ☑ 0-10V dimming

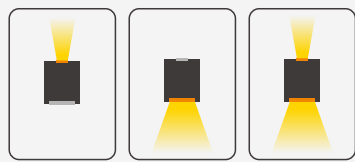

### Product Display



### Suspending Accessories

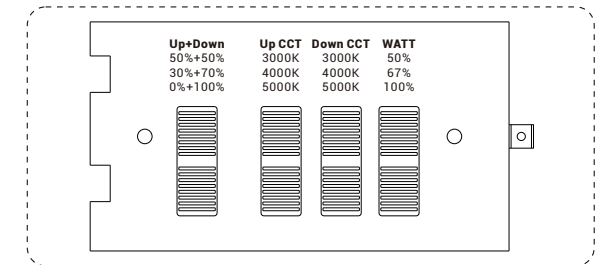

### Product Line Drawing (Size:mm)

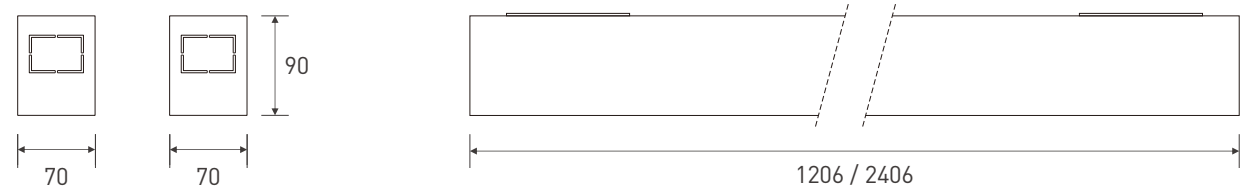

### Product Specification

Material : AL+PC	PC Cover : Frosted	CCT : <input type="checkbox"/> 3000K <input type="checkbox"/> 4000K <input type="checkbox"/> 5000K
------------------	--------------------	--

Model	Size	Power	CRI	Package
LY-SF90L1200-60W6	4ft	60W	>80	1300*215*245 (mm) 6pcs/ctn
LY-SF90L2400-120W6	8ft	120W	>80	2500*115*170 (mm) 2pcs/ctn

Applications: Include any commercial office, school, hotel, hospital and many other spaces.





# Led Linear Fixture

This is a LED Linear light that combined with non dimmable and 0-10V dimming. It can meet the challenges of your industrial, shops, warehouse and task lighting need.



## Features

- ☑ Connected up to 600W in a line
- ☑ 0-10V dimming optional
- ☑ Seamless & No Dark in-line connection



### Emergency light



### Product Line Drawing (Size:mm)

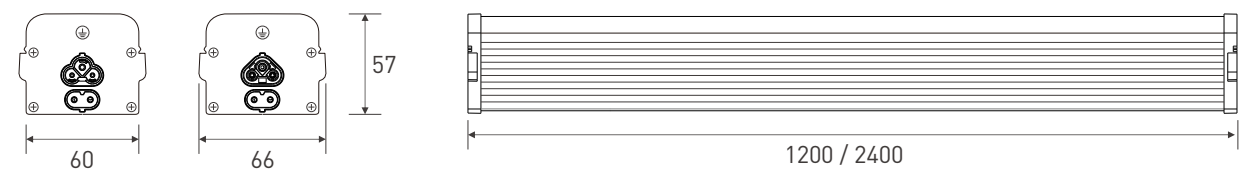

### Product Specification

Material : AL+PC	PC Cover : Frosted / Clear	CCT : <input type="checkbox"/> 3000K <input type="checkbox"/> 4000K <input type="checkbox"/> 5000K
------------------	----------------------------	--

Model	Size	Power	CRI	Package
LY-SF90L1200-60W2	4ft	60W	>80	1390*225*205 (mm) 9pcs/ctn
LY-SF90L2400-120W2	8ft	120W	>80	2590*155*145 (mm) 4pcs/ctn

#### Product Display



#### Accessories

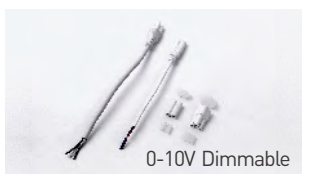
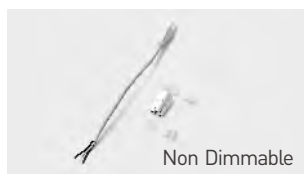

Applications: Include Warehousing, Manufacturing, Gymnasiums, And Other Large Indoor Spaces





# Retrofit Led Linear Light

Led linear strip light can address virtually any indoor lighting need



## Features

- ✓ Easy Removable, Detachable Through Spring Button Design
- ✓ Knock-out End Cap For Continuous Mounting
- ✓ Heat protection system, with excellent internal driver

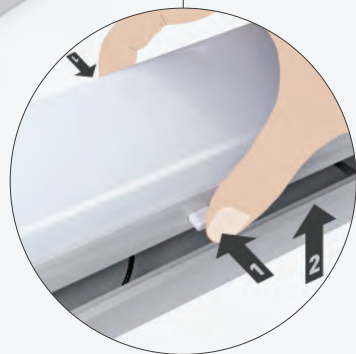

■ Spring button

■ Power entry from the back

■ Drop-proof with safety rope

■ Suspending Optional



## ••• Installation

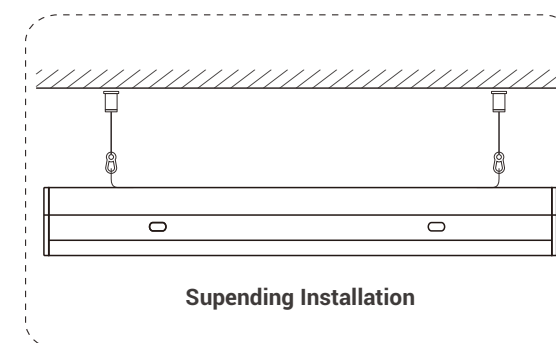
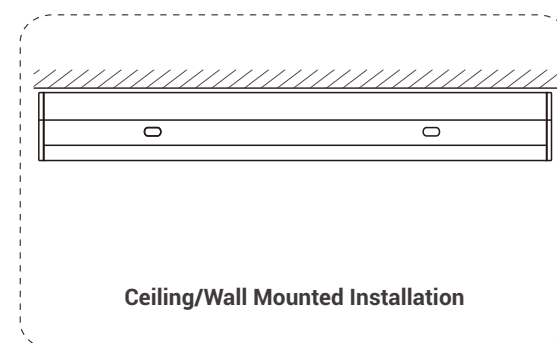

## ••• Product Line Drawing (Size:mm)

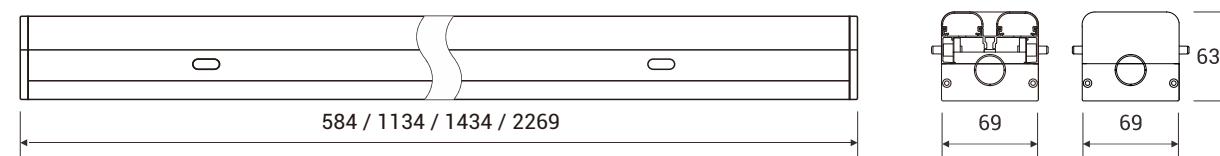

## ••• Product Specification

Material : AL+PC	PC Cover : Frosted / Clear	CCT : <input type="checkbox"/> 3000K <input type="checkbox"/> 4000K <input type="checkbox"/> 5000K <input type="checkbox"/> 6000K
------------------	----------------------------	---

Model	Size	Power	CRI	Beam Angle	Package
LY-SF90L600-20W	2ft	20W	>80	120	690*190*235 (mm) 6pcs/ctn
LY-SF90L1200-40W	4ft	40W	>80	120	1290*190*235 (mm) 6pcs/ctn
LY-SF90L1500-60W	5ft	60W	>80	120	1590*190*235 (mm) 6pcs/ctn
LY-SF90L2400-80W	8ft	80W	>80	120	2490*105*160 (mm) 2pcs/ctn

••• Applications: Work Areas, Shopping Mall, Office, Home etc



# 0-10V Dimming T8 Led Integrated Light

Fixed Forever Once Locked, Never Worry About Electricity Leaking  
Low UGR Integrated Lighting



## Features

- ✓ 0-10V Dimming
- ✓ Fall-away Prevention Design
- ✓ Self Locking Buckle Linkable



### Self-locking Buckle Connection

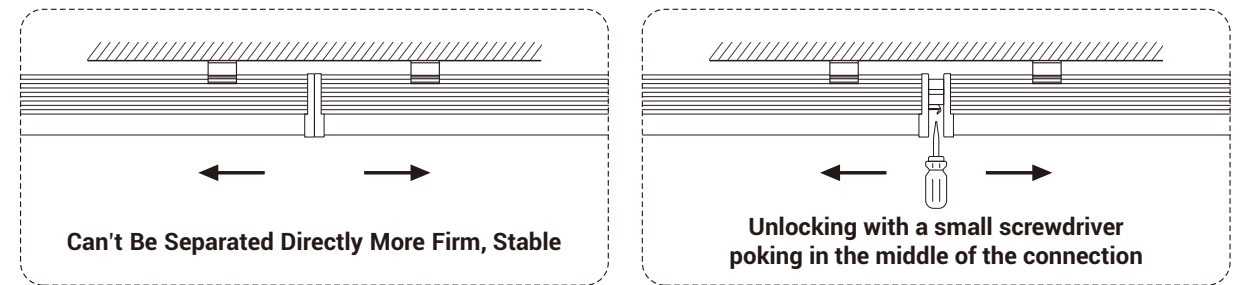

### Product Line Drawing (Size:mm)

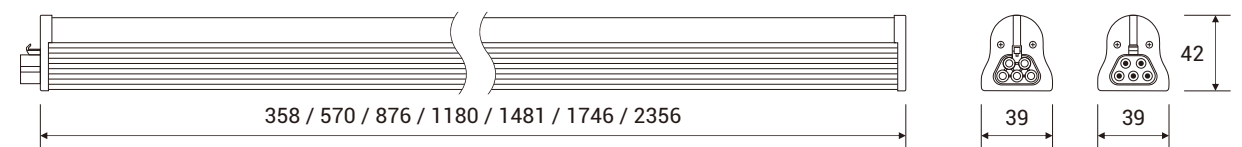

### Product Specification

Material : AL+PC	PC Cover : Frosted / Clear	CCT : <input type="checkbox"/> 3000K <input type="checkbox"/> 4000K <input type="checkbox"/> 5000K <input type="checkbox"/> 6000K
------------------	----------------------------	---

Model	Size	Power	CRI	Beam Angle	Package
LY-T8DL600-9W	2ft	9W	>80	120	900*240*205 (mm) 20pcs/ctn
LY-T8DL900-13W	3ft	13W	>80	120	1205*240*205 (mm) 20pcs/ctn
LY-T8DL1200-18W	4ft	18W	>80	120	1510*240*205 (mm) 20pcs/ctn
LY-T8DL1200-22W	4ft	22W	>80	120	1510*240*205 (mm) 20pcs/ctn
LY-T8DL1500-25W	5ft	25W	>80	120	1810*240*205 (mm) 20pcs/ctn
LY-T8DL2400-44W	8ft	44W	>80	120	2685*150*120 (mm) 6pcs/ctn

Applications: Factories, Food Storage, Office Buildings, Hotels etc

#### Connection Ways



#### Self-Locking

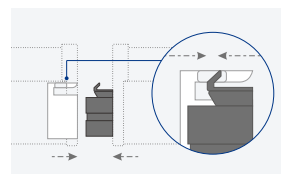

#### End Cap



#### Standard Clip







# 0-10V Dimming Double T5 Integrated Light

Enjoy Hassle-free, safe and easy Installation, Low UGR Integrated Lighting



## Features

- ✓ Patent Male-female linkable design
- ✓ Maximum tandem wattage: 300W optional
- ✓ Seamless & No Dark in-line connection



### ••• Installation

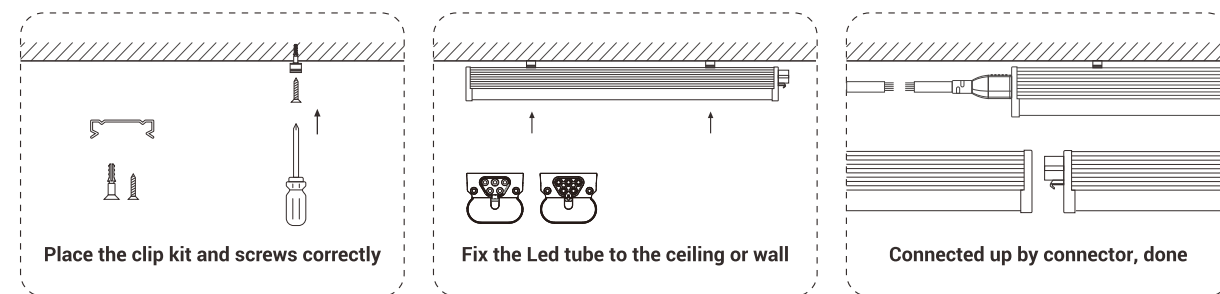

### ••• Product Line Drawing (Size:mm)

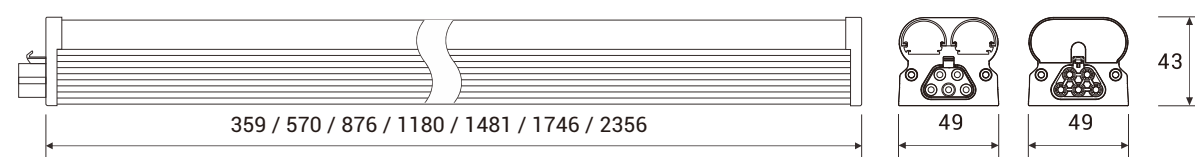

### ••• Product Specification

<b>Material :</b> AL+PC	<b>PC Cover :</b> Frosted / Clear	<b>CCT :</b> <input type="checkbox"/> 3000K <input type="checkbox"/> 4000K <input type="checkbox"/> 5000K <input type="checkbox"/> 6000K
-------------------------	-----------------------------------	--

Model	Size	Power	CRI	Package
LY-T5SL300-8W	1ft	8W	>82	690*280*210(mm) 20pcs/ctn
LY-T5SL600-15W	2ft	15W	>82	900*280*210(mm) 20pcs/ctn
LY-T5SL900-25W	3ft	25W	>82	1205*280*210(mm) 20pcs/ctn
LY-T5SL1200-30W	4ft	30W	>82	1510*280*210(mm) 20pcs/ctn
LY-T5SL1200-40W	4ft	40W	>82	1510*280*210(mm) 20pcs/ctn
LY-T5SL1500-40W	5ft	40W	>82	1810*230*210(mm) 16pcs/ctn
LY-T5SL1800-44W	6ft	44W	>82	2070*230*210(mm) 16pcs/ctn
LY-T5SL2400-60W	8ft	60W	>82	2685*175*120(mm) 6pcs/ctn
LY-T5SL2400-80W	8ft	80W	>82	2685*175*120(mm) 6pcs/ctn

••• Applications: Supermarkets, Office, Hotel, shopping malls etc

#### ■ Connection Ways



#### ■ Self-Locking



#### ■ Led type

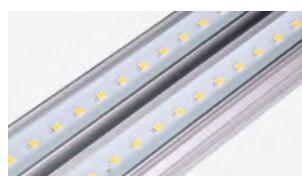

#### ■ Installation Kits





# LED Linear High Bay Light

Compact Tough, Reliable And Safety



## Features

- ✓ Wider Luminous Area
- ✓ 1.3mm Aluminum Housing
- ✓ IP65 Water-proof & Dust-proof



## ••• Installation Ways

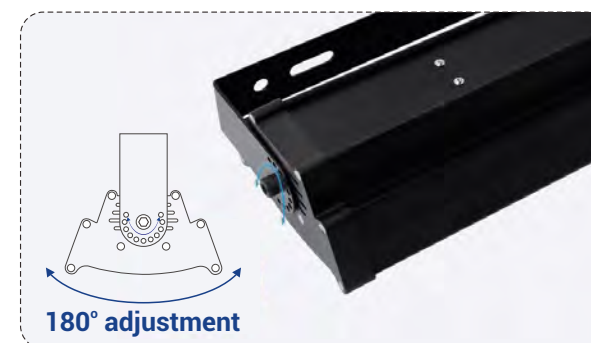

## ••• Highly efficient led light



## ••• Product Line Drawing (Size:mm)

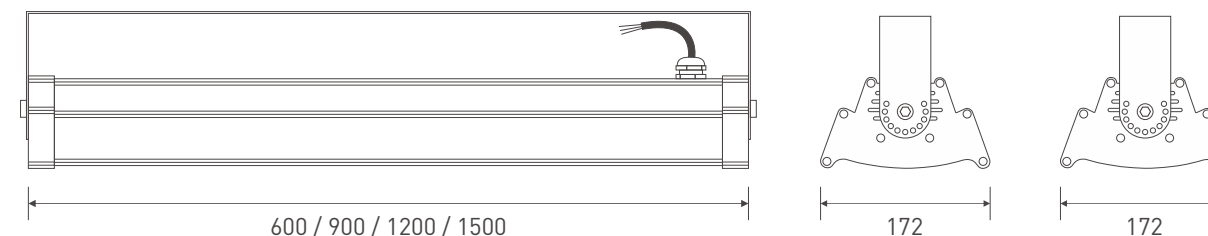

## ••• Product Specification

Material : AL+PC	PC Cover : Frosted / Clear	CCT : <span style="color: yellow;">■</span> 3000K <span style="color: lightgreen;">■</span> 4000K <span style="color: lightblue;">■</span> 5000K <span style="color: blue;">■</span> 6000K
------------------	----------------------------	--

Model	Size	Power	Lumens	CRI	Package
LY-HB180L600-100W	2ft	100W	135lm/w	>80	655*220*170 (mm) 1pc/ctn
LY-HB180L900-150W	3ft	150W	135lm/w	>80	955*220*170 (mm) 1pc/ctn
LY-HB180L1200-200W	4ft	200W	135lm/w	>80	1255*220*170 (mm) 1pc/ctn
LY-HB180L1500-240W	5ft	240W	135lm/w	>80	1555*220*170 (mm) 1pc/ctn

### ■ Product Display



### ■ Power Cable



### ■ Accessories



••• Applications: Workshop, Cold Storage, Facilities, Railway, Train Station etc



# LED Double Linear High Bay Light (I)

Specially For Your Industrial Lighting Needs



## Features

- ☑ Standard Dimming, work with 0-10 V dimmer
- ☑ Efficacy up to 130lm/W
- ☑ Super easy to install



## ••• Installation Ways

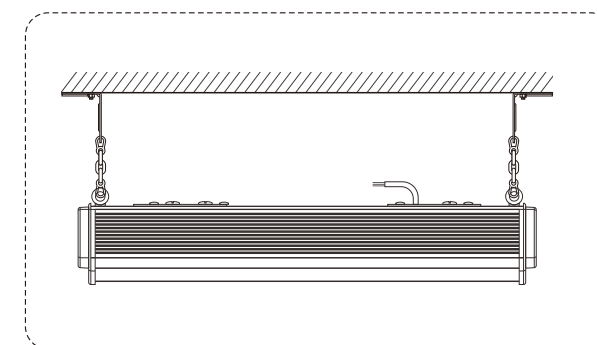
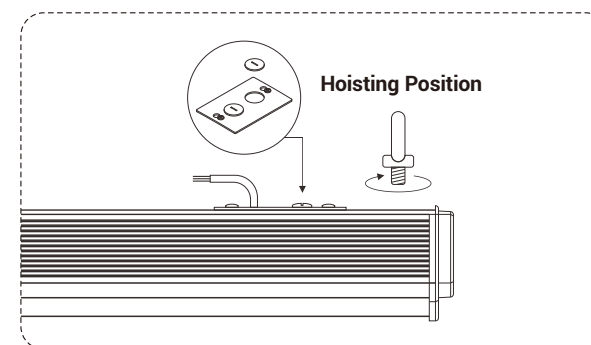

## ••• Product Line Drawing (Size:mm)

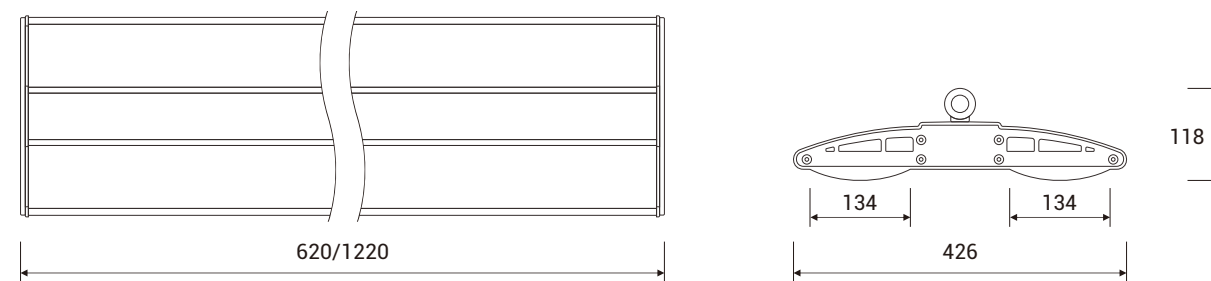

## ••• Product Specification

<b>Material :</b> AL+PC	<b>PC Cover :</b> Frosted / Clear	<b>CCT :</b> <input type="checkbox"/> 3000K <input type="checkbox"/> 4000K <input type="checkbox"/> 5000K <input type="checkbox"/> 6000K
-------------------------	-----------------------------------	--

Model	Size	Power	CRI	Package
LY-HB300L600-100W	1x2ft	100W	>80	680*490*120 (mm) 1pc/ctn
LY-HB300L1200-165W	1x4ft	165W	>80	1280*490*120 (mm) 1pc/ctn

### ■ Product Display



### ■ Accessories



••• **Applications:** Warehouses · Gym, Workshops, Factories And Assembly Plants etc.

# LED Double Linear High Bay Light (II)

Ideal For One-For-One Replacement Of Conventional HID And Fluorescent High Bay Systems



## Features

- ☑ 0-10V Dimming Standard
- ☑ Lumen Up To 140Lm/W
- ☑ Easy Installation, Suitable For Suspension By Chain



## ••• Installation Ways

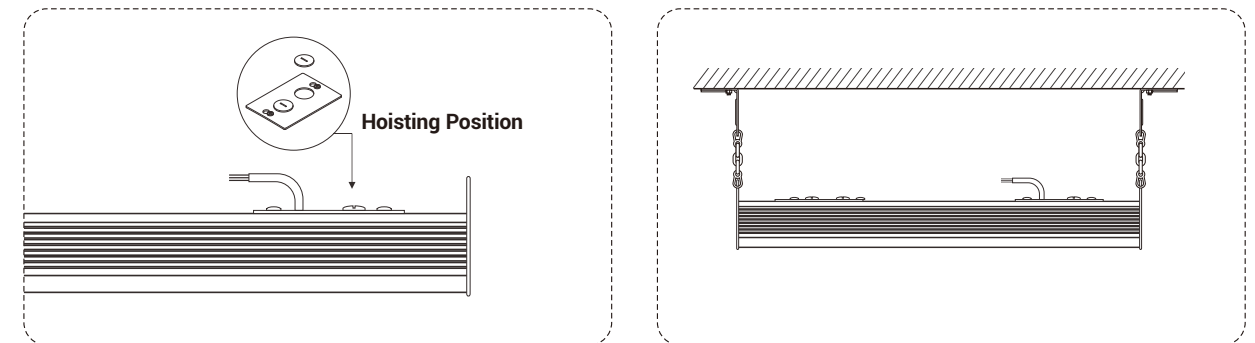

## ••• Product Line Drawing (Size:mm)

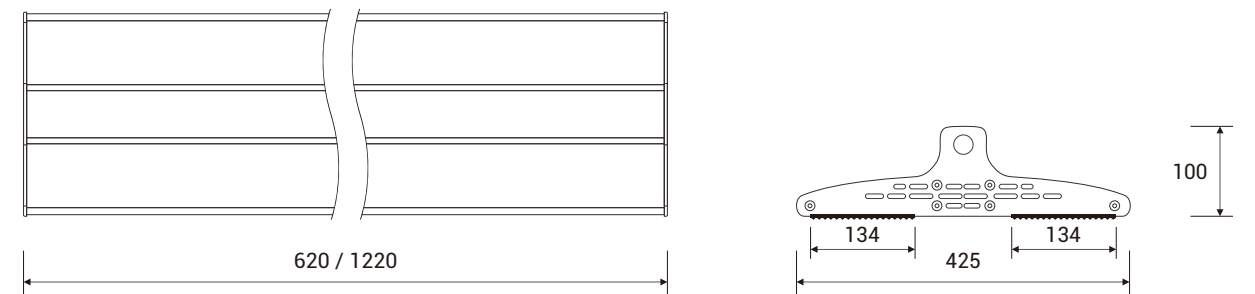

## ••• Product Specification

Material : AL+PC	PC Cover : Prism	CCT : <input type="checkbox"/> 3000K <input type="checkbox"/> 4000K <input type="checkbox"/> 5000K <input type="checkbox"/> 6000K
------------------	------------------	---

Model	Size	Power	CRI	Package
LY-HB300L600-100W	1x4ft	100W	>80	660*480*160 (mm) 1pc/ctn
LY-HB300L1200-165W	1x4ft	165W	>80	1260*480*160 (mm) 1pc/ctn

### ■ Product Display



### ■ Accessories



••• Applications: Include Warehousing, Manufacturing, Gymnasiums, And Other Large Indoor Spaces



# Led Linear High Bay Fixture

Excellent Manufacturing Quality, Used In Large-scale Public Places



## Features

- ✓ High Output 140LM/W
- ✓ Large Luminous Area
- ✓ Easy Installation With Lower Cost



## Product Line Drawing (Size:mm)

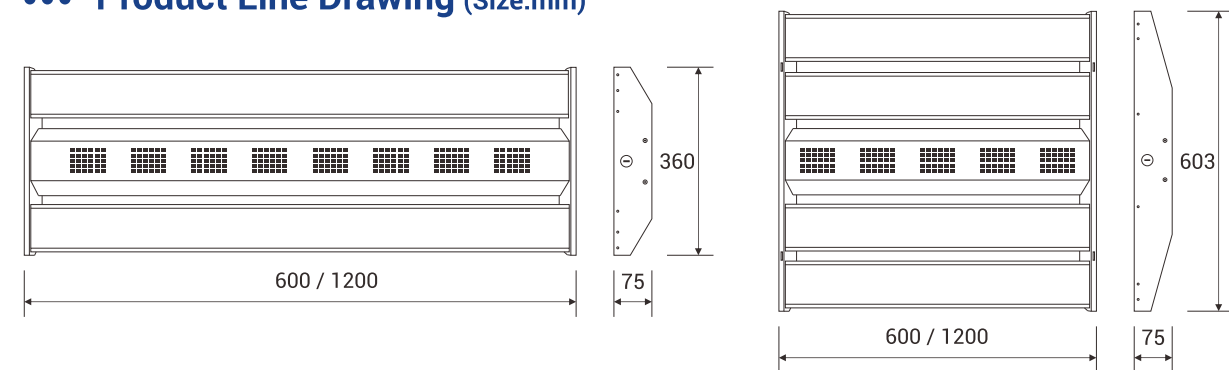

## Product Specification

Material : AL+PC	PC Cover : Prism	CCT : <input type="checkbox"/> 3000K <input type="checkbox"/> 4000K <input type="checkbox"/> 5000K <input type="checkbox"/> 6000K
------------------	------------------	---

Model	Size	Power	CRI	Package
LY-HB300L600-80WP	1x2ft	80W	>80	650*430*250 (mm) 2pcs/ctn
LY-HB300L600-100WP	1x2ft	100W	>80	650*430*250 (mm) 2pcs/ctn
LY-HB300L1200-165WP	1x4ft	165W	>80	1210*425*250 (mm) 2pcs/ctn
LY-HB600L600-200WP	2x2ft	200W	>80	640*660*230 (mm) 2pcs/ctn
LY-HB600L1200-320WP	2x4ft	320W	>80	1210*660*220 (mm) 2pcs/ctn

### Product Display



### Standard Accessories



Applications: Workshop, Warehouse, Storage, Plant, Sports Stadium etc

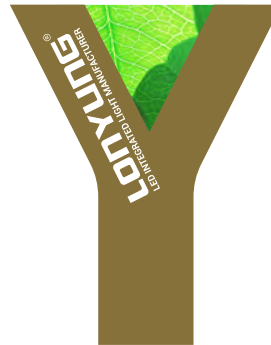

# Led Tri-proof Light

Extremely Safe Lighting In Various Situations



## Features

- ☑ Water-proof
- ☑ Dust-proof
- ☑ Pressure-proof



- Linkable
- Junction-Box mounted
- Suspending
- Standard Clip



## Product Line Drawing (Size:mm)

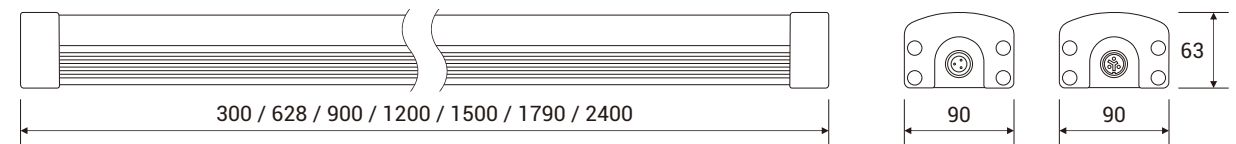

## Product Specification

Material : AL+PC    PC Cover : Frosted / Clear striped    CCT :  3000K    4000K    5000K    6000K

Model	Size	Power	CRI	Beam Angle	Package
LY-SF90L300-20W	1ft	20W	>80	120	550*205*220 (mm) 6pcs/ctn
LY-SF90L600-30W	2ft	30W	>80	120	880*205*220 (mm) 6pcs/ctn
LY-SF90L900-40W	3ft	40W	>80	120	1150*205*220 (mm) 6pcs/ctn
LY-SF90L1200-60W	4ft	60W	>80	120	1450*205*220 (mm) 6pcs/ctn
LY-SF90L1500-80W	5ft	80W	>80	120	1750*205*220 (mm) 6pcs/ctn
LY-SF90L1800-90W	6ft	90W	>80	120	2040*205*155 (mm) 4pcs/ctn
LY-SF90L2400-120W	8ft	120W	>80	120	2650*110*155 (mm) 2pcs/ctn

Applications: Underground Parking Lot, Garage, Tunnel, Metro Station etc



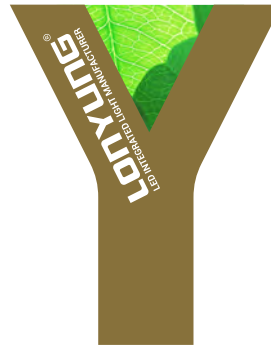

# Mini Led Tri-proof Light

Economic Solution For Led Tri-proof Light



## Features

- ☑ Water-proof
- ☑ Dust-proof
- ☑ Connect Up To 600w



## Product Line Drawing (Size:mm)

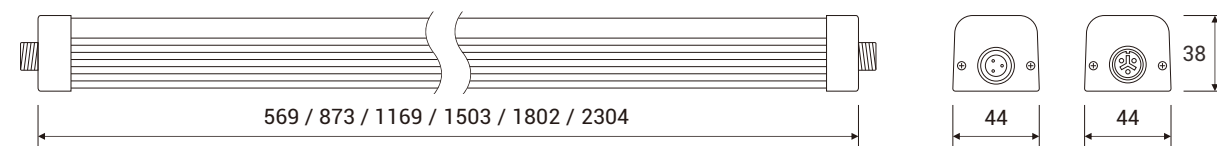

## Product Specification

Material : AL+PC	PC Cover : Frosted / Clear	CCT : <span style="color: yellow;">■</span> 3000K <span style="color: orange;">■</span> 4000K <span style="color: lightblue;">■</span> 5000K <span style="color: blue;">■</span> 6000K
------------------	----------------------------	--

Model	Size	Power	CRI	Beam Angle	Package
LY-T5SL600-15W(M)	2ft	15W	>80	120	710*260*180 (mm) 20pcs/ctn
LY-T5SL900-25W(M)	3ft	25W	>80	120	1015*260*180 (mm) 20pcs/ctn
LY-T5SL1200-30W(M)	4ft	30W	>80	120	1310*260*180 (mm) 20pcs/ctn
LY-T5SL1200-40W(M)	4ft	40W	>80	120	1310*260*180 (mm) 20pcs/ctn
LY-T5SL1500-40W(M)	5ft	40W	>80	120	1645*210*180 (mm) 16pcs/ctn
LY-T5SL1800-44W(M)	6ft	44W	>80	120	1945*210*180 (mm) 16pcs/ctn
LY-T5SL2400-60W(M)	8ft	60W	>80	120	2445*160*146 (mm) 9pcs/ctn

Applications: Warehouse, Airport, Factory, Indoor Stadium etc

### Linkable



### Non-Linkable



### Connection Cable



### Power Cord



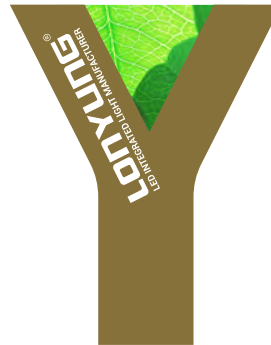

# Plastic Led Integrated Light

Good Lighting Products, LONYUNG Created



## Features

- ☑ Cost-Effective
- ☑ IP66 Rating
- ☑ 180° Beam Angle



### Product Line Drawing (Size:mm)

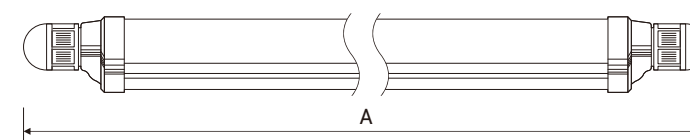
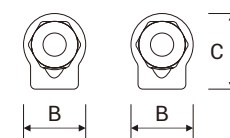

A	B	C
637	33	40
944	33	40
1247	33	40
1547	33	40

### Product Specification

Material : PC	PC Cover : Frosted / Clear	CCT : <span style="color: yellow;">■</span> 3000K <span style="color: lightgreen;">■</span> 4000K <span style="color: lightblue;">■</span> 5000K <span style="color: blue;">■</span> 6000K
---------------	----------------------------	--

Model	Size	Power	CRI	Beam Angle	Package
LY-T8DL600-9WP	2ft	9W	>80	180	830*240*220 (mm) 25pcs/ctn
LY-T8DL900-13WP	3ft	13W	>80	180	1135*240*220 (mm) 25pcs/ctn
LY-T8DL1200-18WP	4ft	18W	>80	180	1440*240*220 (mm) 25pcs/ctn
LY-T8DL1500-22WP	5ft	22W	>80	180	1740*240*220 (mm) 25pcs/ctn

■ Linkable

■ Non-Linkable

■ Waterproof connection

■ Standard Clip

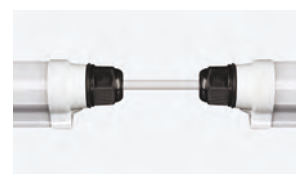

••• Applications: Refrigerator, Fridge, Icebox, Cooler, Storeroom, Aquarium etc





# Led Batten Light (I)

Elegant Design, Unique 3 Rows Light



## Features

- ☑ Batten Lampshade
- ☑ Smooth And Uniform Light
- ☑ Seamless / No-dark Connection



- Seamless Connection
- CCT Adjustable
- On/Off Switch
- Straight Connector

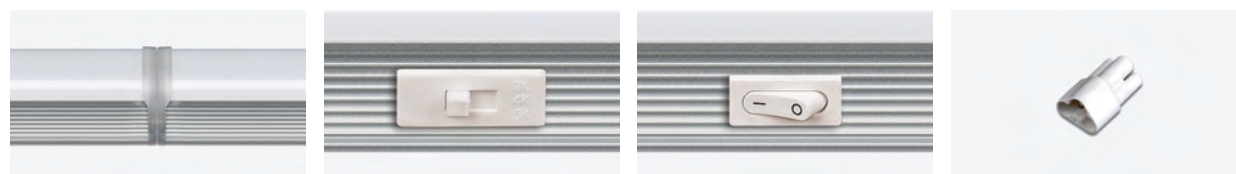

## Product Line Drawing (Size:mm)

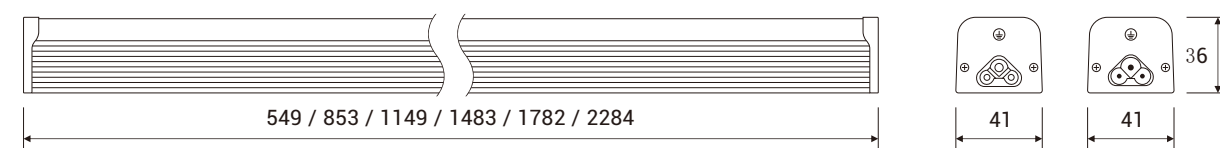

## Wiring Method

### Single Wired

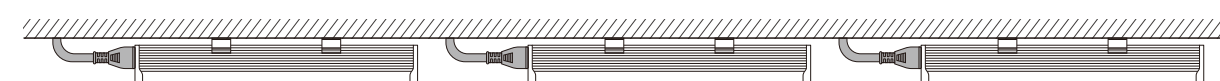

### Linkable

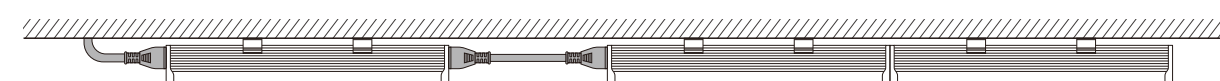

## Product Specification

Material : AL+PC	PC Cover : Frosted / Clear	CCT : <input type="checkbox"/> 3000K <input type="checkbox"/> 4000K <input type="checkbox"/> 5000K <input type="checkbox"/> 6000K
------------------	----------------------------	---

Model	Size	Power	CRI	Beam Angle	Package
LY-T5SL600-15W	2ft	15W	>80	120	710*260*180 (mm) 20pcs/ctn
LY-T5SL900-25W	3ft	25W	>80	120	1015*260*180 (mm) 20pcs/ctn
LY-T5SL1200-30W	4ft	30W	>80	120	1310*260*180 (mm) 20pcs/ctn
LY-T5SL1200-40W	4ft	40W	>80	120	1310*260*180 (mm) 20pcs/ctn
LY-T5SL1500-40W	5ft	40W	>80	120	1645*210*180 (mm) 16pcs/ctn
LY-T5SL1800-44W	6ft	44W	>80	120	1945*210*180 (mm) 16pcs/ctn
LY-T5SL2400-60W	8ft	60W	>80	120	2445*160*146 (mm) 9pcs/ctn

Applications: Commercial Buidling, Library, Lobby, Hall etc



# Led Cabinet Light (I)

For Greater Kitchen Lighting Improvements



## Features

- ✓ Easy Installation
- ✓ Seamless Connection
- ✓ Under Cabinet Lighting



On/Off Switch



CCT Adjustable



Power Cord with Plug

### Product Line Drawing (Size:mm)

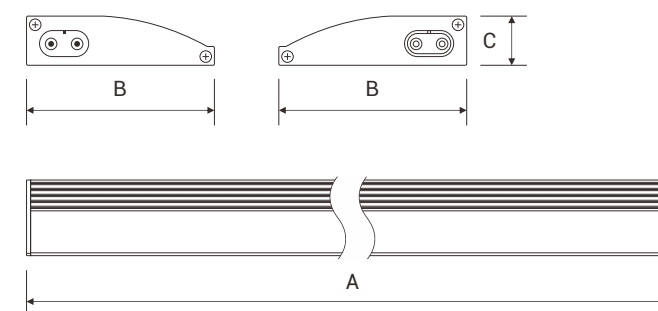

A	B	C
356	65	17
567	65	17
874	65	17
1177	65	17

### Product Specification

Material : AL+PC	PC Cover : Frosted	CCT : <input type="checkbox"/> 3000K <input type="checkbox"/> 4000K <input type="checkbox"/> 5000K <input type="checkbox"/> 6000K
------------------	--------------------	---

Model	Size	Power	CRI	Package
LY-CG65L300-4W	1ft	4W	>80	540*165*250 (mm) 20pcs/ctn
LY-CG65L600-7W	2ft	7W	>80	750*165*250 (mm) 20pcs/ctn
LY-CG65L900-12W	3ft	12W	>80	1060*165*250 (mm) 20pcs/ctn
LY-CG65L1200-15W	4ft	15W	>80	1360*165*250 (mm) 20pcs/ctn
LY-CG65L1200-20W	4ft	20W	>80	1360*165*250 (mm) 20pcs/ctn

#### Seamless Connection



#### Connecting Cable



#### Straight Connector



Applications: Under And Over Cabinets, Display Cases, Task Lighting, Work Areas etc



# Led Cabinet Light (II)

Square Design, Light Up Your Life



## Features

- ☑ Square Design
- ☑ Seamless Connection
- ☑ Under Cabinet Lighting



■ Connection



■ Connecting Cable



■ Straight Connector



■ Standard Clip

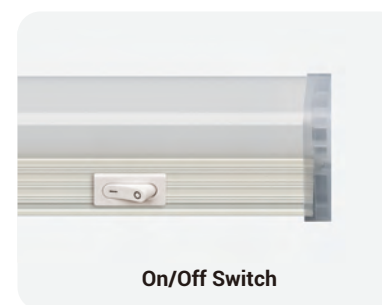

### Product Line Drawing (Size:mm)

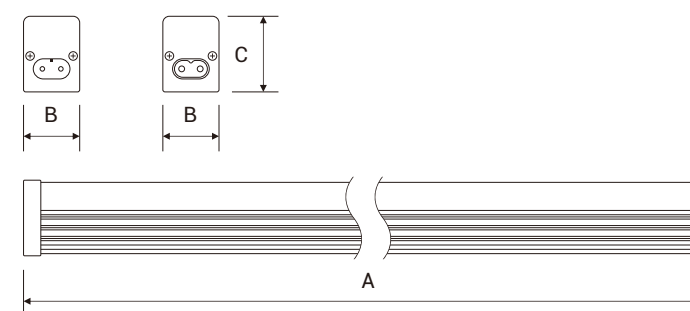

A	B	C
360	26	35
571	26	35
878	26	35
1181	26	35

### Product Specification

Material : AL+PC	PC Cover : Frosted / Clear	CCT : <input type="checkbox"/> 3000K <input type="checkbox"/> 4000K <input type="checkbox"/> 5000K <input type="checkbox"/> 6000K
------------------	----------------------------	---

Model	Size	Power	CRI	Beam Angle	Package
LY-T5FL300-4W	1ft	4W	>80	120	570*200*230 (mm) 25pcs/ctn
LY-T5FL600-7W	2ft	7W	>80	120	780*200*230 (mm) 25pcs/ctn
LY-T5FL900-12W	3ft	12W	>80	120	1085*200*230 (mm) 25pcs/ctn
LY-T5FL1200-15W	4ft	15W	>80	120	1390*200*230 (mm) 25pcs/ctn
LY-T5FL1200-20W	4ft	20W	>80	120	1390*200*230 (mm) 25pcs/ctn

Applications: Under And Over Cabinets, Display Cases, Task Lighting, Work Areas etc

# Led T8 Integrated Light

Classical Integrative Original Design From LONYUNG



## Features

- ✓ Patent Male-female Linkable Design
- ✓ Seamless Connection
- ✓ Curved Lens Provides >120° Beam



## Product Line Drawing (Size:mm)

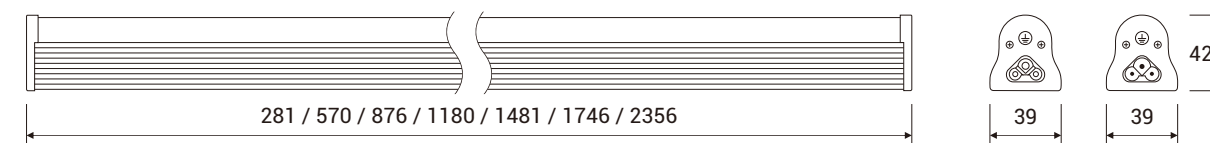

## Product Specification

Material : AL+PC	PC Cover : Frosted / Clear	CCT : <input type="checkbox"/> 3000K <input type="checkbox"/> 4000K <input type="checkbox"/> 5000K <input type="checkbox"/> 6000K
------------------	----------------------------	---

Model	Size	Power	CRI	Beam Angle	Package
LY-T8DL300-5W	1ft	5W	>80	120	435*240*205 (mm) 20pcs/ctn
LY-T8DL600-9W	2ft	9W	>80	120	725*240*205 (mm) 20pcs/ctn
LY-T8DL900-13W	3ft	13W	>80	120	1035*240*205 (mm) 20pcs/ctn
LY-T8DL1200-18W	4ft	18W	>80	120	1335*240*205 (mm) 20pcs/ctn
LY-T8DL1200-22W	4ft	22W	>80	120	1335*240*205 (mm) 20pcs/ctn
LY-T8DL1500-25W	5ft	25W	>80	120	1640*240*205 (mm) 20pcs/ctn
LY-T8DL1800-28W	6ft	28W	>80	120	1900*240*205 (mm) 20pcs/ctn
LY-T8DL2400-44W	8ft	44W	>80	120	2510*150*166 (mm) 9pcs/ctn

### Connection Ways



### Standard Clip



Applications: Storage, Retail And Grocery Store, Parking Lot etc



# Single T5 Integrated Light (I)

Good Lighting Products, LONYUNG Created



## Features

- ✓ Patent Male-female Linkable Design
- ✓ Seamless Connection
- ✓ Linkable Max 200w And 600W Version Fixing Clip

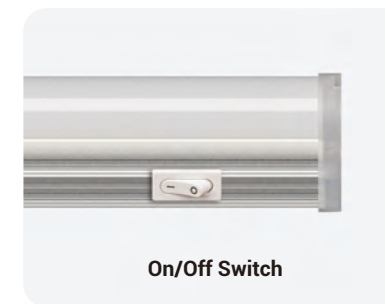

## Product Line Drawing (Size:mm)

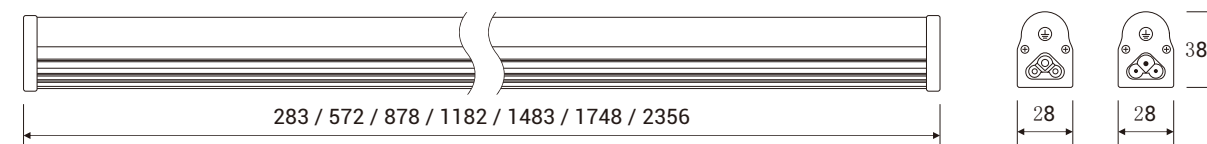

## Product Specification

Material : AL+PC	PC Cover : Frosted / Clear	CCT : <input type="checkbox"/> 3000K <input type="checkbox"/> 4000K <input type="checkbox"/> 5000K <input type="checkbox"/> 6000K
------------------	----------------------------	---

Model	Size	Power	CRI	Beam Angle	Package
LY-T5DL300-4W	1ft	4W	>80	120	490*175*230 (mm) 25pcs/ctn
LY-T5DL600-7W	2ft	7W	>80	120	780*175*230 (mm) 25pcs/ctn
LY-T5DL900-12W	3ft	12W	>80	120	1085*175*230 (mm) 25pcs/ctn
LY-T5DL1200-15W	4ft	15W	>80	120	1390*175*230 (mm) 25pcs/ctn
LY-T5DL1500-20W	5ft	20W	>80	120	1690*175*230 (mm) 25pcs/ctn
LY-T5DL1800-22W	6ft	22W	>80	120	1955*175*190 (mm) 20pcs/ctn
LY-T5DL2400-30W	8ft	30W	>80	120	2565*175*145 (mm) 15pcs/ctn

### Connection Ways



### Connection Cable



### Standard Clip



Applications: Restaurant, Store, Supermarket, Display Rack etc

# Single T5 Integrated Light (II)

Great Performance, Reasonable Cost



## Features

- ✓ Patent Male-female Linkable Design
- ✓ Seamless Connection
- ✓ CCT Adjustable Optional



## Product Line Drawing (Size:mm)

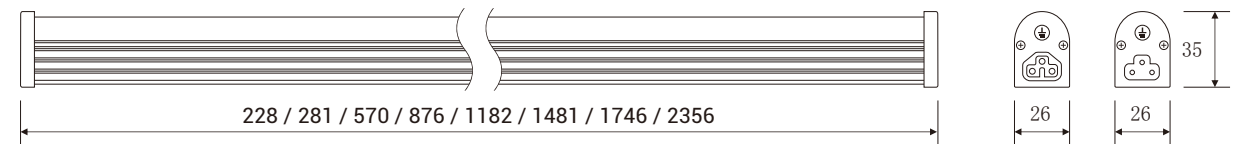

## Product Specification

Material : AL+PC	PC Cover : Frosted / Clear	CCT : <input type="checkbox"/> 3000K <input type="checkbox"/> 4000K <input type="checkbox"/> 5000K <input type="checkbox"/> 6000K
------------------	----------------------------	---

Model	Size	Power	CRI	Beam Angle	Package
LY-T5DL222-4W	9in	4W	>80	120	490*175*230 (mm) 25pcs/ctn
LY-T5DL300-4W	1ft	4W	>80	120	490*175*230 (mm) 25pcs/ctn
LY-T5DL600-7W	2ft	7W	>80	120	780*175*230 (mm) 25pcs/ctn
LY-T5DL900-12W	3ft	12W	>80	120	1085*175*230 (mm) 25pcs/ctn
LY-T5DL1200-15W	4ft	15W	>80	120	1390*175*230 (mm) 25pcs/ctn
LY-T5DL1500-20W	5ft	20W	>80	120	1690*175*230 (mm) 25pcs/ctn
LY-T5DL1800-22W	6ft	22W	>80	120	1955*175*190 (mm) 20pcs/ctn
LY-T5DL2400-30W	8ft	30W	>80	120	2565*175*145 (mm) 15pcs/ctn

Applications: Home, Hotel, Kitchen, Task Lighting etc

### Connection Ways



### Straight Connector

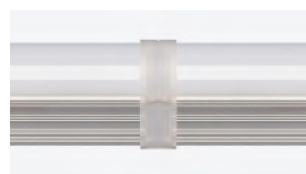

### Standard Clip





# Double T5 Integrated Light (I)

Globally Original Double Tube Design, Elegant Appearance



## Features

- ✓ Double Led Strip Design
- ✓ Excellent Brightness
- ✓ Linkable Max 200w And 600W Version Optional



- On/Off Switch
- Power On The Back
- Suspending Kits
- Standard Clip

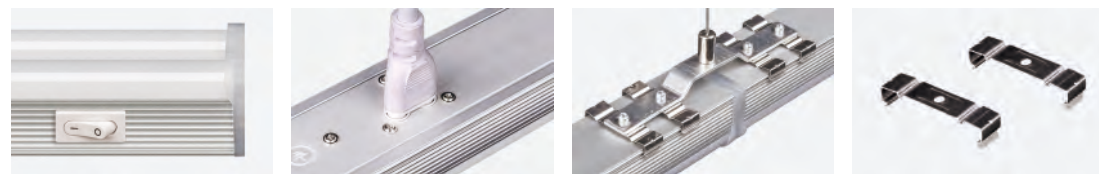

## ••• Installation

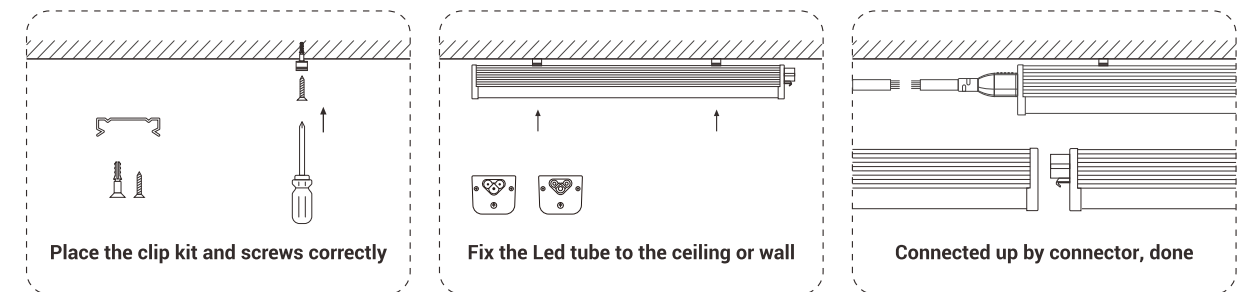

## ••• Product Line Drawing (Size:mm)

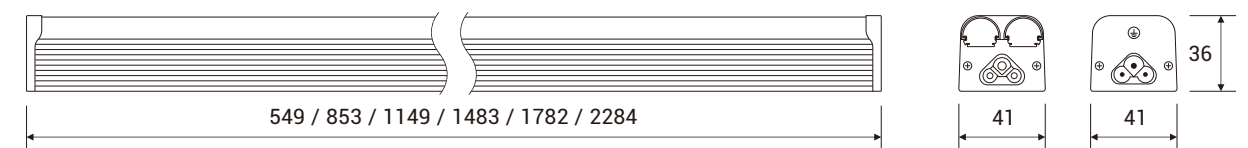

## ••• Product Specification

Material : AL+PC	PC Cover : Frosted / Clear	CCT : <input type="checkbox"/> 3000K <input type="checkbox"/> 4000K <input type="checkbox"/> 5000K <input type="checkbox"/> 6000K
------------------	----------------------------	---

Model	Size	Power	CRI	Beam Angle	Package
LY-T5SL600-15W	2ft	15W	>80	90 / 210	710*260*180 (mm) 20pcs/ctn
LY-T5SL900-25W	3ft	25W	>80	90 / 210	1015*260*180 (mm) 20pcs/ctn
LY-T5SL1200-30W	4ft	30W	>80	90 / 210	1310*260*180 (mm) 20pcs/ctn
LY-T5SL1200-40W	4ft	40W	>80	90 / 210	1310*260*180 (mm) 20pcs/ctn
LY-T5SL1500-40W	5ft	40W	>80	90 / 210	1645*210*180 (mm) 16pcs/ctn
LY-T5SL1800-44W	6ft	44W	>80	90 / 210	1945*210*180 (mm) 16pcs/ctn
LY-T5SL2400-60W	8ft	60W	>80	90 / 210	2445*160*146 (mm) 9pcs/ctn

••• Applications: Retail And Grocery Store, Warehouse, Factory, Workshop etc

# Double T5 Integrated Light (II)

Classical Integrative Original Design From LONYUNG



## Features

- ✓ Double Led Strip Design
- ✓ More Flatter And Slimmer
- ✓ Greater Light Angle (>180° Beam)



## Product Line Drawing (Size:mm)

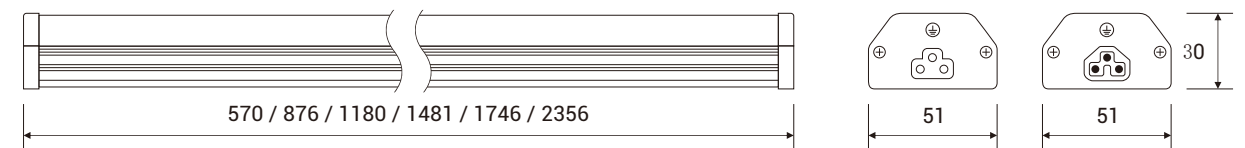

## Wiring Method

### Single Wired

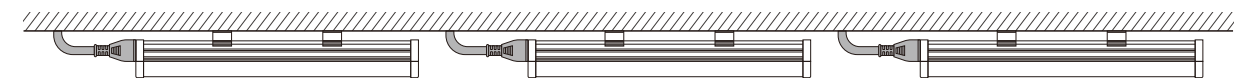

### Linkable

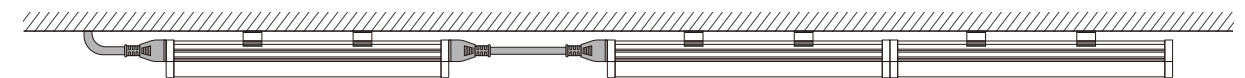

## Product Specification

Material : AL+PC	PC Cover : Frosted / Clear	CCT : <input type="checkbox"/> 3000K <input type="checkbox"/> 4000K <input type="checkbox"/> 5000K <input type="checkbox"/> 6000K
------------------	----------------------------	---

Model	Size	Power	CRI	Beam Angle	Package
LY-T5SL600-15W	2ft	15W	>80	180	735*235*190 (mm) 20pcs/ctn
LY-T5SL900-25W	3ft	25W	>80	180	1045*235*190 (mm) 20pcs/ctn
LY-T5SL1200-30W	4ft	30W	>80	180	1345*235*190 (mm) 20pcs/ctn
LY-T5SL1200-40W	4ft	40W	>80	180	1345*235*190 (mm) 20pcs/ctn
LY-T5SL1500-40W	5ft	40W	>80	180	1645*235*155 (mm) 16pcs/ctn
LY-T5SL1800-44W	6ft	44W	>80	180	1910*235*155 (mm) 16pcs/ctn
LY-T5SL2400-60W	8ft	60W	>80	180	2520*180*120 (mm) 9pcs/ctn

### Connection Ways



### Standard Clip



Applications: Warehouse, Aisle, Shopping Center, Garage etc



# Led T8 Tube Light

Classical Product, Global Reputation



## Features

- ☑ Replacement Traditional Fluorescent T8 And T12 Lighting
- ☑ Energy Savings More Than 60%
- ☑ 0.8mm Aluminum Housing



## Product Line Drawing (Size:mm)

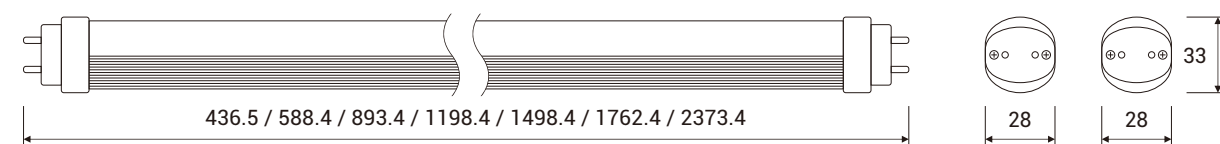

## Connection Ways

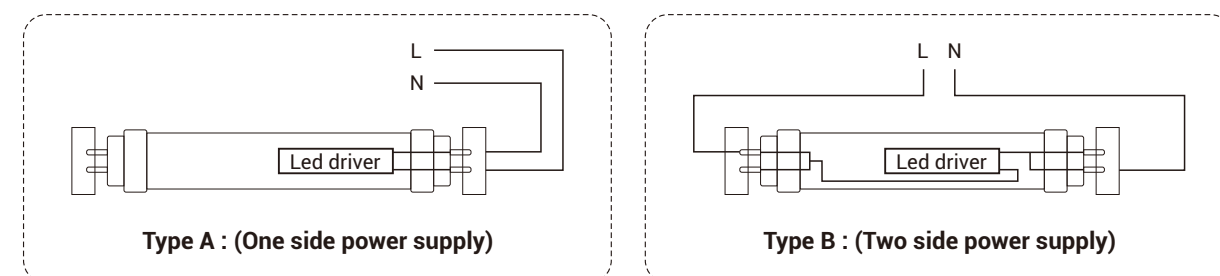

## Product Specification

Material : AL+PC	PC Cover : Frosted / Clear	CCT : <input type="checkbox"/> 3000K <input type="checkbox"/> 4000K <input type="checkbox"/> 5000K <input type="checkbox"/> 6000K
------------------	----------------------------	---

Model	Size	Power	CRI	Beam Angle	Package
LY-T8L600-9W	2ft	9W	>80	120	670*340*200 (mm) 50pcs/ctn
LY-T8L900-13W	3ft	13W	>80	120	980*340*200 (mm) 50pcs/ctn
LY-T8L1200-9W	4ft	9W	>80	120	1280*275*200 (mm) 40pcs/ctn
LY-T8L1200-16W	4ft	16W	>80	120	1280*275*200 (mm) 40pcs/ctn
LY-T8L1200-18W	4ft	18W	>80	120	1280*275*200 (mm) 40pcs/ctn
LY-T8L1500-22W	5ft	22W	>80	120	1580*210*180 (mm) 30pcs/ctn
LY-T8L1800-28W	6ft	28W	>80	120	1845*210*180 (mm) 30pcs/ctn
LY-T8L2400-44W	8ft	44W	>80	120	2460*175*165 (mm) 20pcs/ctn

Applications: Supermarkets, Shopping Mall, Entertainment Venues, Factories etc

- G13
- Rotatable G13
- R17D
- Fa8
- T8 To T5





# Formable Led Fixture

Various Shape And Beam Angle Available According To Your Project Request



## Features

- ☑ Deformable To Different Shape, Wattage And Beam Angle
- ☑ High Lumen Output
- ☑ Hassle-free, Safe And Easy Installation

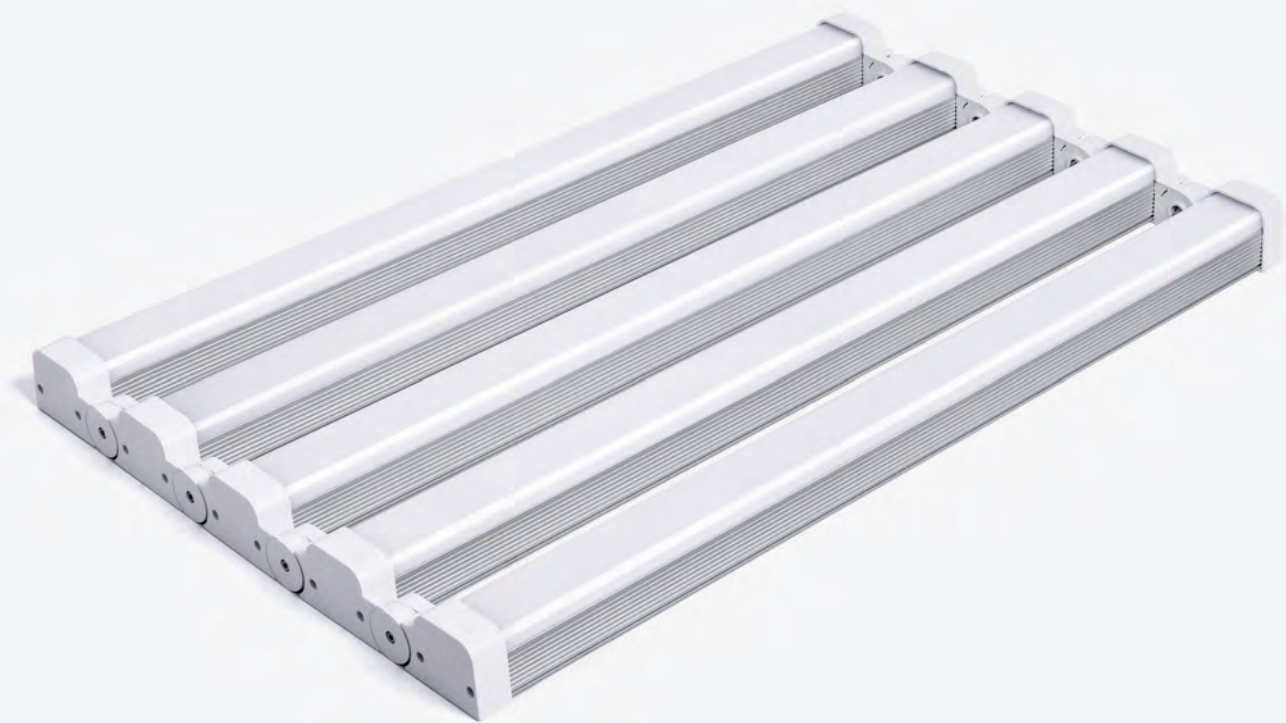

### ••• Shape Optional

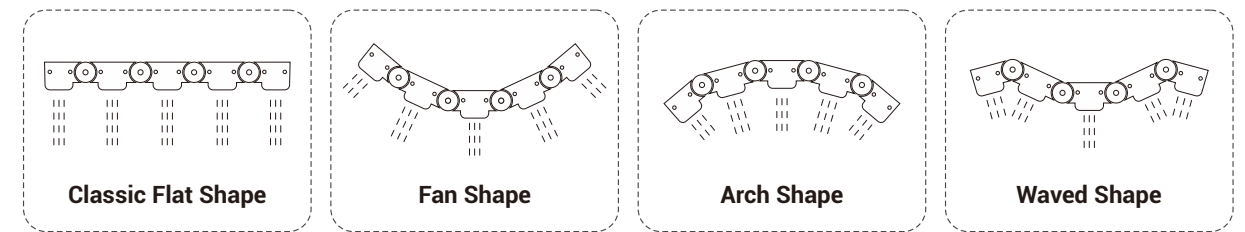

### ••• Product Line Drawing (Size:mm)

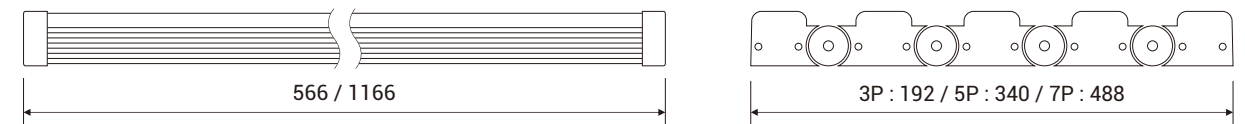

### ••• Product Specification

<b>Material :</b> AL+PC	<b>PC Cover :</b> Frosted / Clear	<b>CCT :</b> <input type="checkbox"/> 3000K <input type="checkbox"/> 4000K <input type="checkbox"/> 5000K <input type="checkbox"/> 6000K
-------------------------	-----------------------------------	--

Model	Size	Power	CRI	Package
LY-3PL600-45W	2ft	45W	>80	745*210*225 (mm) 5pcs/ctn
LY-5PL600-75W	2ft	75W	>80	705*220*365 (mm) 5pcs/ctn
LY-7PL600-105W	2ft	105W	>80	705*220*510 (mm) 5pcs/ctn
LY-3PL1200-90W	4ft	90W	>80	1345*210*225 (mm) 5pcs/ctn
LY-5PL1200-150W	4ft	150W	>80	1305*220*365 (mm) 5pcs/ctn
LY-7PL1200-210W	4ft	210W	>80	1305*135*510 (mm) 3pcs/ctn

### ■ Shape Optional



••• **Applications:** Warehouses, Workshops, Storage, Factories, Gyms etc





reddot award  
honourable mention

# Led Pod Light

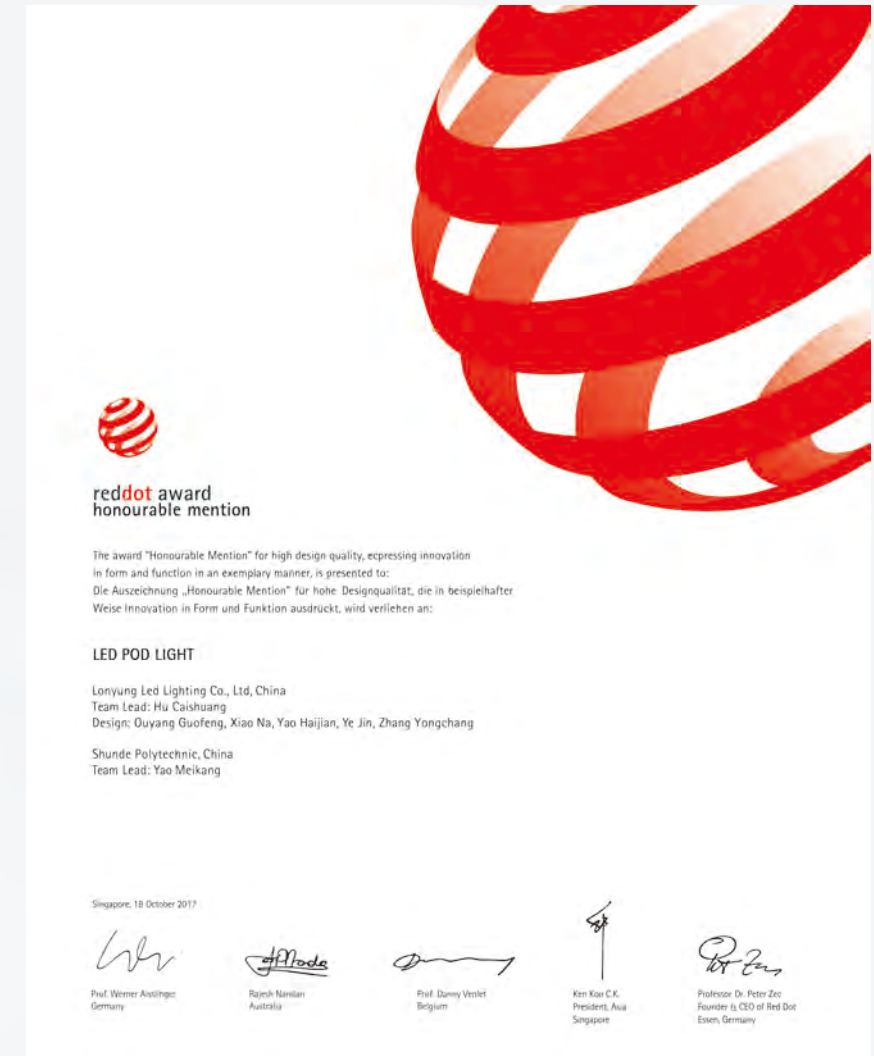

reddot award  
honourable mention

The award "Honourable Mention" for high design quality, expressing innovation in form and function in an exemplary manner, is presented to:  
Die Auszeichnung „Honourable Mention“ für hohe Designqualität, die in beispielhafter Weise Innovation in Form und Funktion ausdrückt, wird verliehen an:

### LED POD LIGHT

Lonyung Led Lighting Co., Ltd, China  
Team Lead: Hu Caishuang  
Design: Ouyang Guofeng, Xiao Na, Yao Haijian, Ye Jin, Zhang Yongchang

Shunde Polytechnic, China  
Team Lead: Yao Meikang

Singapore, 18 October 2017

Prof. Werner Aisslinger  
Germany

Rajesh Narain  
Australia

Prof. Danny Verlet  
Belgium

Ken Koo C.K.  
President, Asia  
Singapore

Professor Dr. Peter Zec  
Founder & CEO of Red Dot  
Essen, Germany



reddot award  
winner

# Led Camping Lantern

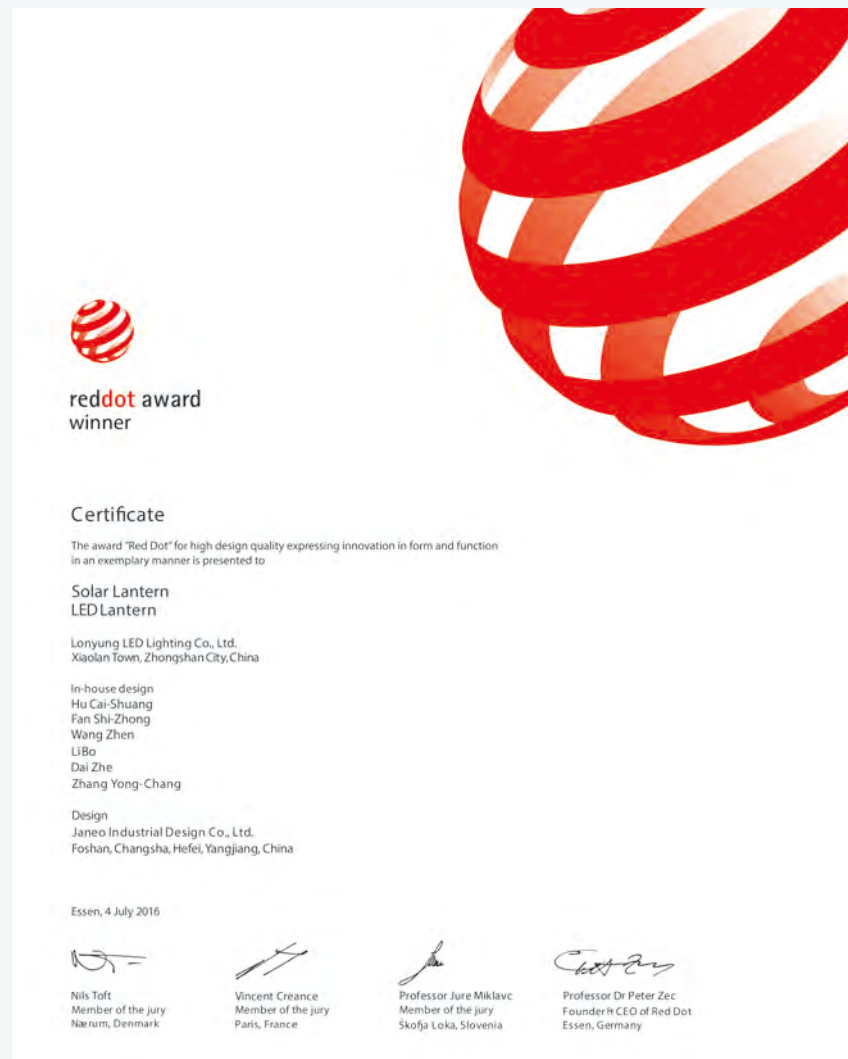





# Led Camping Lantern

Reddot Product Design Award, Cute Gift



## Features

- ☑ Shatter-resistant
- ☑ Ip65 Waterproof
- ☑ USB Charging



- 100% Lighting
- 20% Lighting
- Mosquito Repellent
- SOS
- Ip65



## ••• Charge Mode



## ••• Lighting

The Max. Luminous Flux of 100% Lighting	≥100Lm
The Max. Luminous Flux of 20% Lighting	≥20Lm
100% Lighting time after fully charged	≥4hours
20% Lighting time after fully charged	≥7hours

## ••• Specification

Input Voltage	5.2V	Input Current	200MA
Fully Charged Time	2Hours	Product Size	φ 80x70mm
Product Weight	102g±1g	Battery	1000mAH Li-ion Battery
Package	425x355x380mm 80pcs/ctn		

**LONYUNG®**  
LED INTEGRATED LIGHT MANUFACTURER

LONYUNG LED LIGHTING CO.,LTD

Tel: 86-760-2218 2786

Fax: 86-760-2383 2030

E-mail: info@lonyung.com

Address: Block2, number 39, East Jucheng Rd, Xiaolan  
Town, Zhongshan City, China

<https://www.lonyung.com>

<https://lonyunglighting.com>

<https://lonyung.en.alibaba.com>

<https://lonyungled.en.alibaba.com>

<https://lonyunglighting.en.alibaba.com>

Lonyung

Copyright © LONYUNG 2010-2023